



ASI094MC Pro Manual

Revision 1.1

Mar, 2018

All materials related to this publication are subject to change without notice and its copyright totally belongs to Suzhou ZWO CO.,LTD.



Table of Contents

ASI094MC Pro Manual.....	1
1. Instruction	3
2. What's in the box?.....	4
3. Camera technical specifications.....	5
4. QE Graph & Read Noise.....	6
5. Getting to know your camera.....	8
5.1 External View.....	8
5.2 DDR Buffer.....	9
5.3 Power Consumption.....	9
5.4 Cooling System.....	10
5.5 Back Focus Distance.....	10
5.6 Protective Window.....	10
5.7 Analog to Digital Converter (ADC).....	11
5.8 Binning.....	11
5.9 Tilt Adjustment.....	11
6. How to use your camera.....	12
7. Cleaning	14
8. Mechanical drawing.....	15
9. Servicing	15
10. Warranty	15



1. Instruction

Congratulations and thank you for buying one of our ASI cameras ! This manual will give you a brief introduction to your ASI camera. Please take the time to read it thoroughly and if you have any other questions, feel free to contact us.

info@zwoptical.com

ASI094MC Pro Camera is designed for astronomical photography. This is our first Full-Frame size CMOS camera which is not only suitable for DSO imaging, but also for planetary imaging. The excellent performance and multifunctional usage will impress you a lot!

Model	Mono or Color	Regulated TEC Cooling	DDR3 buffer	Sensor
ASI094MC Pro	Color	Yes	256MB	SONY IMX094

For software installation instructions and other technical information please refer to “ASI USB3.0 Cameras software Manual”

<https://astronomy-imaging-camera.com/>

2. What's in the box?

ASI094MC Pro Camera



camera bag



camera body



M42-M48 adapter



quick guide



USB3.0 cable



M54-M48 21mm extender



M48-M48 16.5mm extender



2" cover



hexagon wrench



0.5m USB 2.0 cable X2

3. Camera technical specifications

Sensor	SONY IMX094 CMOS
Diagonal	43.3mm
Resolution	36.35 Mega Pixels 7376X4928
Pixel Size	4.88 μ m
Image area	36mmX24mm
Max FPS at full resolution	4.8FPS
Shutter	Rolling shutter
Exposure Range	32 μ s-2000s
Read Noise	2.2e @24db gain
QE peak	56%
Full well	53k e
ADC	14 bit
DDR3 buffer	256MB
Interface	USB3.0/USB2.0
Adapters	M54*0.75
Protect window	AR window
Window Heater Power	3.6W
Dimensions	86mm Diameter
Weight	640g
Back Focus Distance	17.5mm
Cooling:	Regulated Two Stage TEC
Delta T	30°C -35°C below ambient
Cooling Power consumption	12V at 3A Max
Supported OS	Windows, Linux & Mac OSX
Working Temperature	-5°C~45°C
Storage Temperature	-20°C~60°C
Working Relative Humidity	20%~80%
Storage Relative Humidity	20%~95%

4. QE Graph & Read Noise

QE and Read noise are the most important parts to measure the performance of a camera. Higher QE and Lower read noise are needed to improve the SNR of an image.

Here is the relative QE graph of ASI094MC Pro.

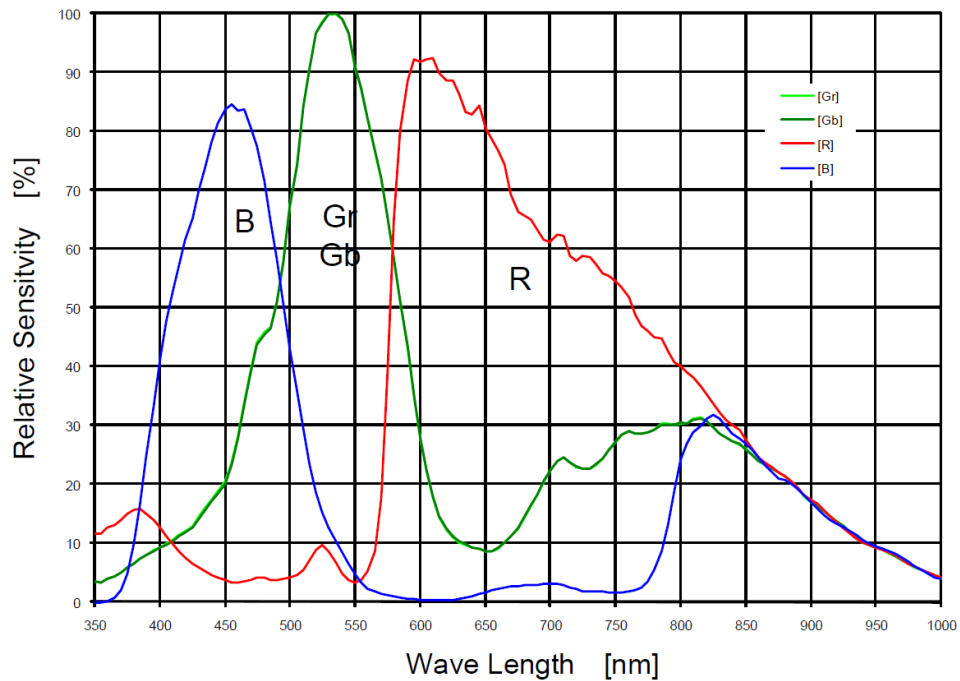

Read noise includes pixel diode noise, circuit noise and ADC quantization error noise, and the lower the better.

The Read Noise of the ASI094MC Pro camera is extremely low when compared with traditional CCD cameras and it is even lower when the camera is used at a higher gain.

Depending on your target, you can set the gain lower for higher dynamic range (longer exposure) or set the gain higher for lower noise (such as short exposure or lucky imaging).

Read noise, full well, gain and dynamic range for ASI094

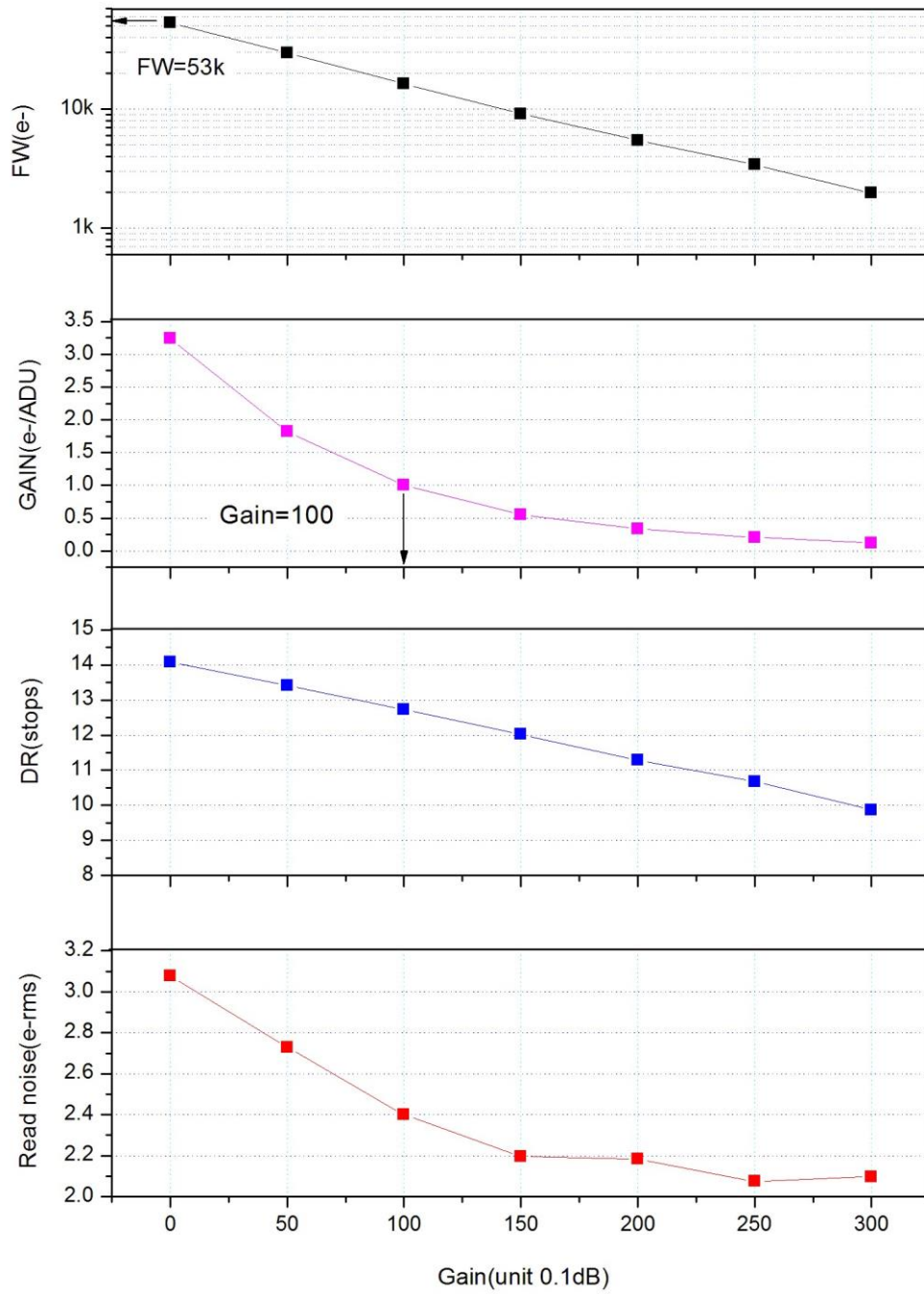

5. Getting to know your camera

5.1 External View



5.2 DDR Buffer

The ASI094 Pro camera includes a 256MB DDR3 memory buffer to help improve data transfer reliability. Additionally, the use of a memory buffer minimizes amp-glow, which is caused by the slow transfer speeds when the camera is used with a USB 2.0 port.

DDR memory buffer is the main difference between ASI “Cool” and “Pro” cameras.

5.3 Power Consumption

ASI094 Pro camera has one full frame sensor, so the power consumption (650mA@5V) is much higher than other cameras. But USB3.0 can provide 1000mA current, so ASI094 Pro can run standalone under USB3.0 host, it doesn't need external power supply.

You need to connect the external 12v power supply if you connect the camera to USB 2.0 host which can only provide 500ma current.

Recommended cooler power supply: 12V @ 3-5A (or more) DC adapter (2.1×5.5mm, center pole positive). Also suitable: DC battery with 9-15V.

Here is a test result of the cooler power consumption of ASI094 camera. It only needs 0.5A to cool the camera to 20 degree below ambient.

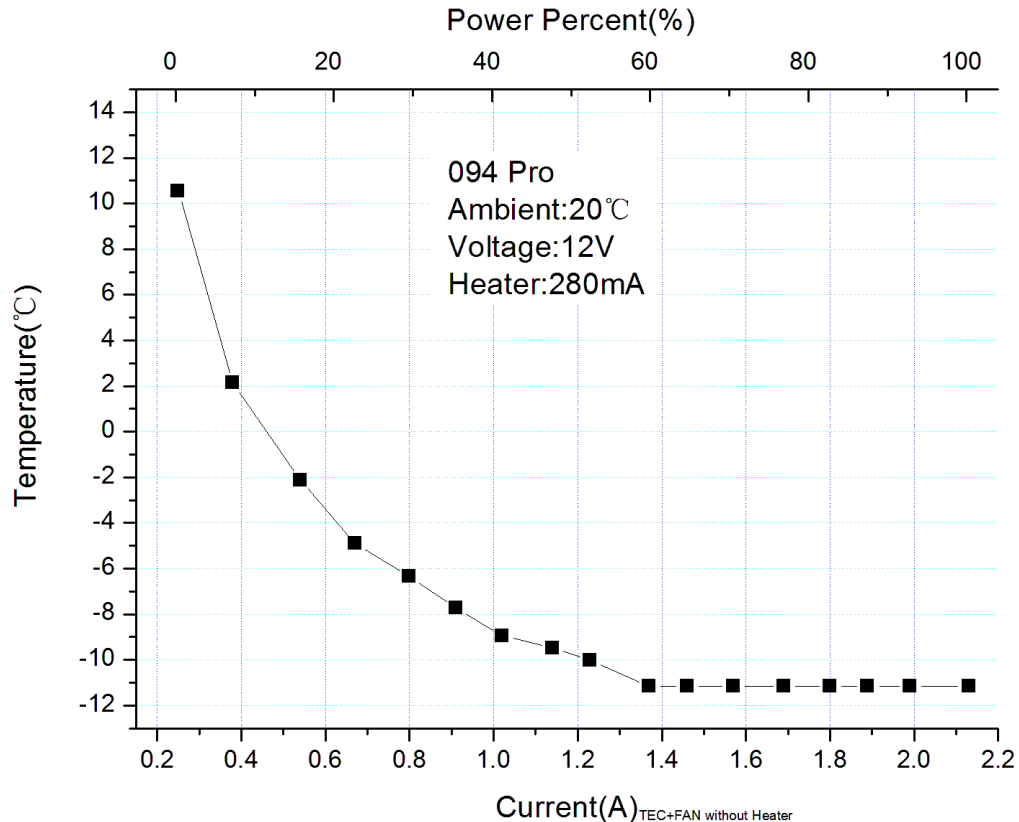

5.4 Cooling System

The ASI094MC Pro camera have a robust, regulated cooling system, which means that the camera sensor can be kept at the desired temperature throughout your imaging session. The super low readout noise, combined with efficient cooling and adjustable gain setting, allows you to do short or lucky DSO imaging unlike the traditional CCD cameras which need very long exposure for each frame. However, keep in mind that cooling won't help with very short exposure such as less than 100ms. The lowest temperature that can be set is $-30^{\circ}\text{C} \sim -35^{\circ}\text{C}$ below ambient.

Here is a dark current test result of ASI094MC Pro sensor at various temperatures.

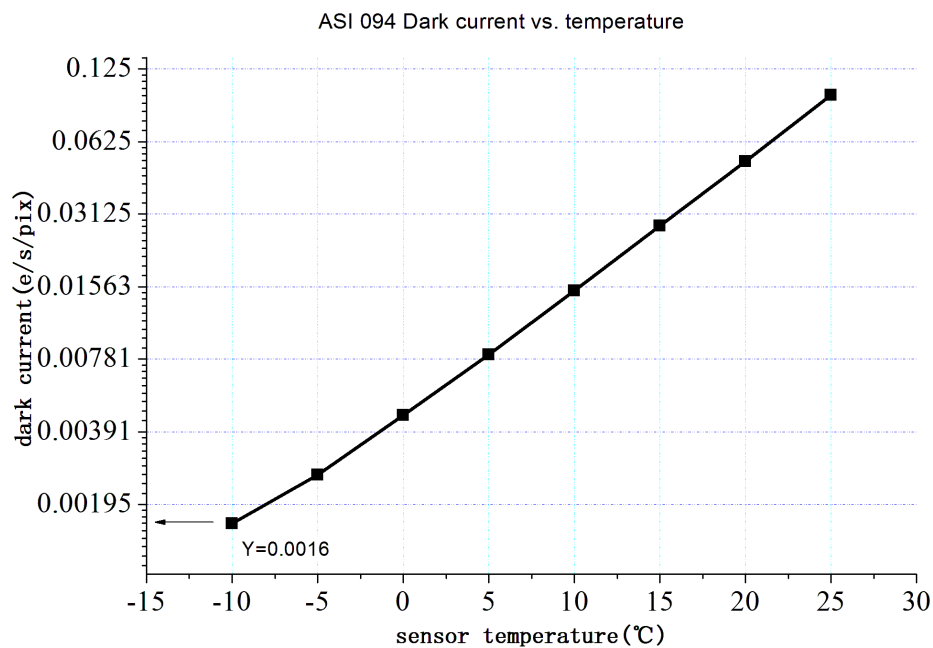

5.5 Back Focus Distance

The M54 female flange to the sensor is 17.5mm. You can reach 55mm back focus distance with the 21mm and 16.5mm extender included in the camera package.

5.6 Protective Window

There is a protective window before the sensor of ASI094MC Pro camera.

It's an AR-AR coated BK7 glass, diameter is 60mm and 2mm thick.

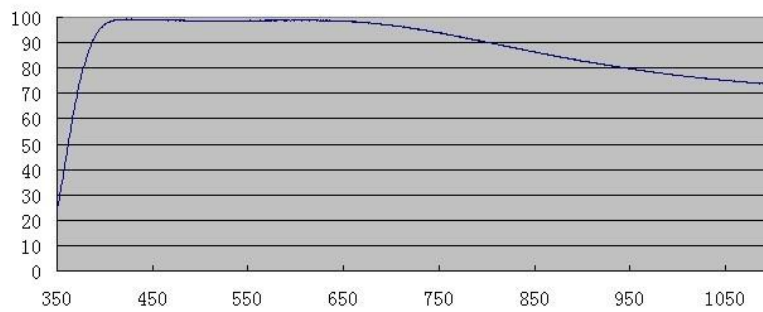

5.7 Analog to Digital Converter (ADC)

The ASI094MC Pro camera records in 14bit ADC. This camera also supports ROI (region of interest) imaging, and smaller ROI has faster fps.

Here is the maximum speed of ASI094MC Pro running under USB2.0 and USB3.0.

Resolution	USB 3.0	USB2.0
	14Bit ADC	
7372×4924	4.75fps	1.19fps
3840×2160	5.22fps	5.22fps
1920×1080	20.87fps	20.87fps
640×480	47.19fps	47.19fps
320×240	91.77fps	91.77fps

5.8 Binning

The ASI094MC Pro camera supports hardware bin3 and software bin2, bin3 and bin4 mode. Hardware binning is supported by sensor but is done in digital domain like software binning and use 10bit ADC. The only advantage of hardware binning is faster fps (25fps). We recommend customer to use software binning if you don't need faster fps.

Just set "hardware binning" on in software to enable hardware binning.

5.9 Tilt Adjustment

The alignment of sensor just like align the primary mirror of Newtonian there is 3 directions you can adjust, each direction have one push and pull screws. You can do like this:



1. Find out which part of the camera have tilt issue from your image and mark it on the camera body, then you can adjust the screws in this direction or opposite direction in next step.

2. Attach the camera to your scope and start live view or continues running mode, loose the pull screw and tight the push screw a little to check if it's better. Otherwise you need to adjust the opposite ones you also need to check other corners after adjustment if this direction is ok now.

3. Repeat step 2 until stars in all corners are perfect.

6. How to use your camera

There are many adapters available for this camera for connecting to your scope or lens. Some are included with the camera and others you can order from our official website:

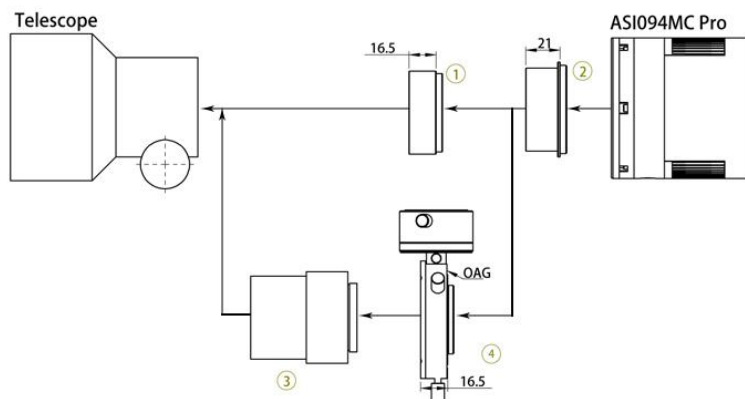

1. M48-M48 16.5mm extender
2. M54-M48 21mm extender
3. Reducer or flat Lens
4. OAG(16.5mm thickness)

Cooled Cameras
External Device Connecting Drawing



7. Cleaning

The camera is sealed and comes with an AR protect window to protect the sensor from dusts and humidity. We don't recommend customer to open the camera for cleaning. The dusts can be removed by post processing with flat frame.

To see the dusts, you just need to set up your telescope and point it to a bright place. A Barlow is required to see these dusts clearly. Then attach the camera and adjust the exposure to make sure not overly exposed. You can see an image like below if it's dirty.

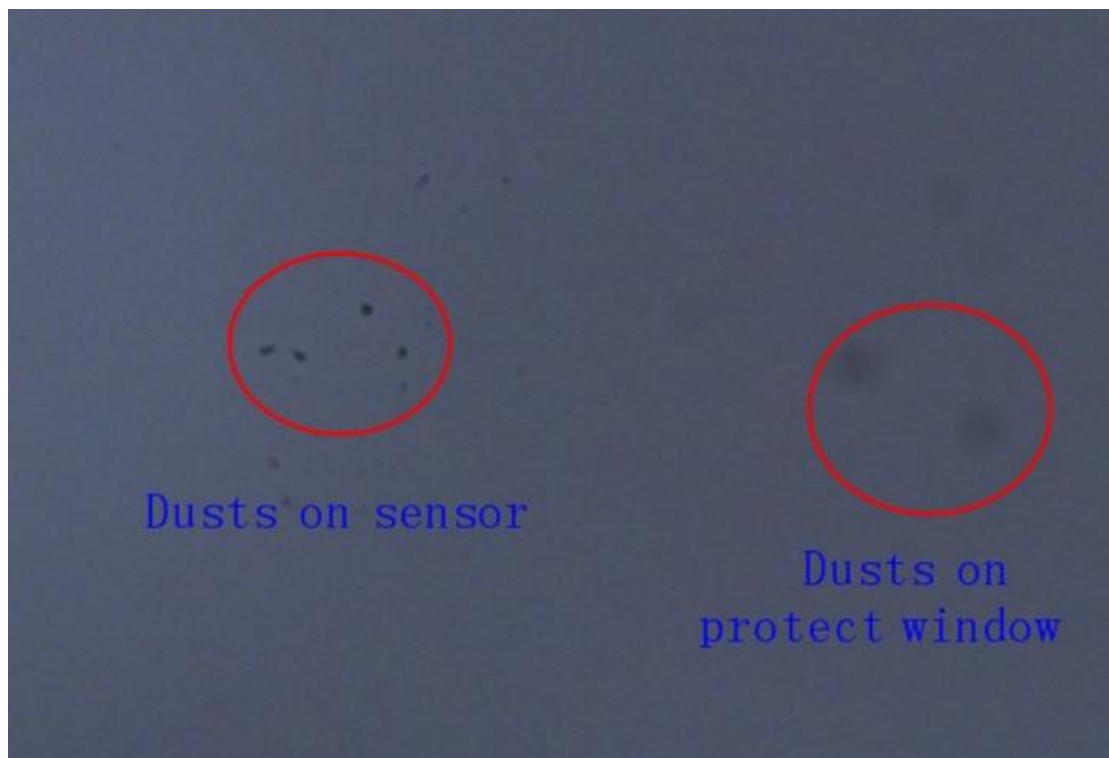

The big dim spot on the image (at right) are the shadows of dust on the protect window.

The very small but very dark spot in the image (at left) are the shadows of the dusts on the sensor.

The suggested way to clean them is try to blow them away with a manual air pump. To clean the dust on the sensor you will need to open the camera chamber.

We have a very detailed instruction on our website:

<https://astronomy-imaging-camera.com/manuals/>

Quickguide

- [ZWO ASI Camera Quick Guide](#)
- [ZWO ASI Cooled Camera Quick Guide](#)
- [How to clean ASI camera and redry the desiccant](#)

8. Mechanical drawing

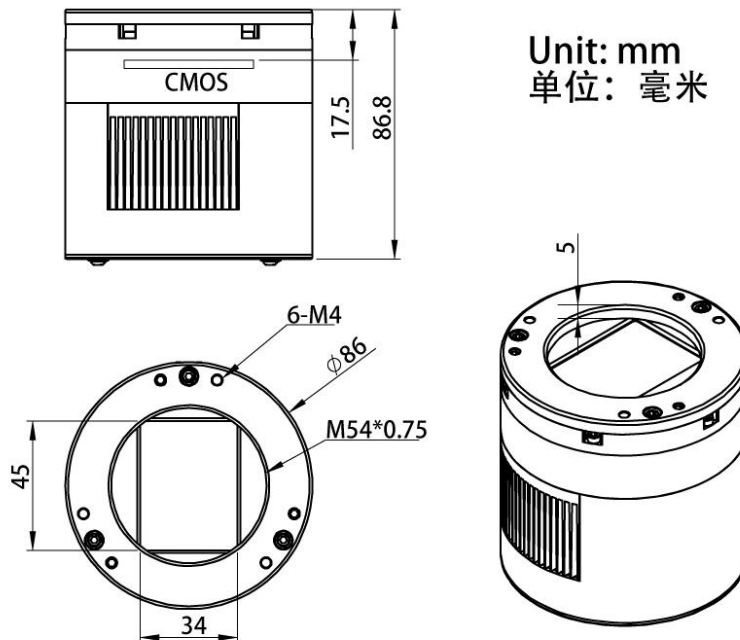

9. Servicing

For software upgrades please refer to “Support-manual and software” on our official website.
<https://astronomy-imaging-camera.com/>

Repairs and servicing are available by emailing info@zwoptical.com

For customers who bought the camera from your local dealer, dealer is responsible for the customer service.

10. Warranty

We provide 2-year warranty for our products. We offer repair service or replacement for free if the camera doesn't work within warranty period.

After the warranty period, we continue to provide repair support and service on a charged basis.

This warranty does not apply to damage that occurred as a result of abuse or misuse, or caused by a fall or any other transportation failures after purchase.

Customer must pay for shipping when shipping the camera back for repair or replacement.